



SOSEN LED Driver, Your Smart Choice

Specifications

SS-100NH-V300BHB LED Driver

Model: SS-100NH-V300BHB

Description: 100W LED Driver

Rev.: V01

Release Date: 2024-11-23

SS-100NH-V300BHB LED Driver

SOSEN
LED DRIVER



LED DRIVER

NH-V 300BHB



Features:

- ❑ Efficiency up to 97%
- ❑ Isolated dimming:0-10V,PWM,Resistor
- ❑ Optional aux: 12V/0.2A
- ❑ Time-controlled programmable
- ❑ Dim to off
- ❑ Standby Power<0.5W
- ❑ Protections: SCP/OTP/OVP/UVF
- ❑ Compatible with intelligent emergency controls
- ❑ Wide output voltage range
- ❑ Dial Power Range Programmable
- ❑ Surge protection: CM: 6kV,DM: 6kV
- ❑ Long lifetime
- ❑ Warranty: 5 years



RoHS

Description:

SS-100NH-V300BHB are 100W non-isolated constant current LED Driver with 108-305VAC. It has DIM to Off, high efficiency, isolated auxiliary power supply, Compatible with intelligent emergency controls,compact housing , fullypotted , high reliability, high cost performance and other advantages.

Applications:

Shoebox Light, Linear high bay light, Flood lighting, Wall lamp

Model List:

Model	AC Input Range	Max. Pout	Vout Range	Recommended Voltage	Iout	Default Current	THD (Typ.)	PF (Typ.)	Eff. (Typ.)	Max.Tc
SS-100NH-V300BHB	108-305Vac	100W	180-300V	260V-300V	0.125-0.5A	0.4A	8%	0.97	97%	90°C

Note:

- 1.Default Tested: at 220Vac, full load, Ta 25°C.
- 2.The performance of the LED Driver can be guaranteed within the full power Vo range.The voltage lower than full power Vo range, it is need to test the performance with the LED module.

SS-100NH-V300BHB LED Driver

“BHB” Means Additional Function

"BHB"	AUX 12V (suffix:H)	Dimming off 0-10V/PWM/Resistor	adjust power (Single DIP)	Photosensitive control	NTC	Remark
BHB	✓	✓	✓			

Input Characteristics:

Parameter	Min.	Typ.	Max.	Remark
Rated AC Input Range	120Vac		277Vac	
AC Input Range	108Vac		305Vac	
Input DC Voltage Range	150Vdc		280Vdc	
Input Frequency Range	47Hz	50/60Hz	63Hz	
Max Input Current			1.2A	120Vac, Full load
Max Input Power			120W	120Vac, Full load
Max Inrush Current(120Vac)			40A	Cold start
Max Inrush Current(220Vac)			80A	Cold start
Max Inrush Current(277Vac)			120A	Cold start
Standby Power			0.5W	220Vac/50Hz, Dim-to-off
Power Factor	0.95	0.97		220Vac, Full load
	0.90			120-277Vac, 70%-100% load
THD		8%	12%	220Vac, Full load
			20%	120-277Vac, 70%-100% load

SS-100NH-V300BHB LED Driver

Output Characteristics:

Parameter	Min.	Typ.	Max.	Remark
O/P Voltage Range	180V		300V	Power derated @180-200V
Rated O/P Voltage	200V		300V	$P_o=V_o \cdot I_o=100W$, Full load
Rated O/P Current	0.33A		0.5A	0.5A for 200V,0.33A for 300V
Adj. O/P Current (AOC)Range	0.125A		0.5A	
No Load Voltage			350V	
Efficiency @120Vac	92.0%	94.0%		Output 300V/0.33A
Efficiency @220Vac	94.0%	96.0%		Output 300V/0.33A
Efficiency @277Vac	95.0%	97.0%		Output 300V/0.33A
O/P Current Tolerance	-5%		+5%	
O/P Current Ripple(PK-AV)		5%	15%	Full load
Start-up Current Overshoot			10%	Full load
Start-up Time			1S	120Vac,Full load
			0.75S	220Vac,Full load
Line Regulation	-5%		+5%	Full load
Load Regulation	-5%		+5%	
Temperature Coefficient	-0.06%/°C		+0.06%/°C	Tc:0°C~90°C
OTP	90°C	95°C	100°C	Drop current when OTP, and it can be automatically restored after the abnormality is removed.
Short Circuit Protection				Driver will not be damaged

SS-100NH-V300BHB LED Driver

Other Characteristics:

Parameter		Min.	Typ.	Max.	Remark
Aux Power	O/P Voltage	10.8V	12V	13.2V	
	O/P Current			200mA	
0-10V Dimming (Optional)	Dim Vmax	0V		12V	DIM+ source current 110uA.
	Dim Range	10%Iomax		100%Ioset	Dimming prohibits reverse connection
	Rec.Dim Range	0V		10V	
PWM Dimming (Optional)	PWM High	9.8V		10.2V	DIM+ source current 110uA.
	PWM Low	0V		0.3V	Dimming prohibits reverse connection
	Frequency	1KHz		2KHz	
	PWM Duty	0%		100%	
Resistor Dimming (Optional)	Resistance	0Kohm		100Kohm	DIM+ source current 110uA.
	Dim Range	10%Iomax		100%Ioset	
Dim to Off	Dim off	0.7V	0.8V	0.9V	Auxiliary source 12V unloaded
	Dim on	0.9V	1.0V	1.1V	
Dial adjustment	Current range	0.132A		0.5A	Dialing range can be set via PC software
Intelligent Emergency Control (Optional, off by default)	Emergency switchover time	3S			AC power failure switching to battery power supply time
	Output Current		8%	10%	Emergency output current can be set via PC software
	Auto-exit time			2H	When the sensor does not detect a signal; configurable
	Access to emergency communications	4Hz duty cycle 25%, high level: 4-10V, low level: 0-0.3V			Duration 30S
	Withdrawal from emergency communications	1Hz duty cycle 25%, high level: 4-10V, low level: 0-0.3V			Duration 2H; configurable
Timing Curve(Optional)	By programming			Set by program	
Lifetime(Tc≤85°C)	≥50,000 hours			80% load	
MTBF	200,150 hours			220Vac, Full load, Ta=25°C (MIL-HDBK-217F)	
Tc	90°C				
Warranty	5 years			Tc: 85°C	
Net Weight	420g				
Dimension	138mm*55mm*32mm			L x W x H	

NOTE: All the parameters above are tested Ta 25°C and LED load, unless specified.

SS-100NH-V300BHB LED Driver

Environmental Requirements

Parameter	Min.	Typ.	Max.	Remark
Operating Temperature(Tcase)	-40°C	25°C	+90°C	
Storage Temperature	-40°C	25°C	+90°C	
Operation Humidity	10%RH		90%RH	
Storage Humidity	5%RH		95%RH	
Altitude	-65m		4000m	

Safety and EMI/EMS Standards

Certification	Standard	Status	Remark
UL/cUL	UL8750	✓	
TUV	EN 61347-2-13:2014/A1:2017 EN61347-1:2015 EN62493:2015		
RCM	AS/NZS61347.2.13		
BIS	IS15885:2012 Part 2 Sec 13		
CCC	GB 19510.14-2009		
CE	EN 61347-2-13:2014 EN61347-1:2008+A1:2011+A2:2013		

EMI/EMS	Criterion	Remark
Conduction Emission	FCC Part15: Subpart B ANSI 63.4:2014	Class A
Radiation Emission	FCC Part15: Subpart B ANSI 63.4:2014	Class A
Harmonic Current Emissions	IEC/EN 61000-3-2:2019+A1:2021	Class C
Surge	IEC/EN 61000-4-5	DM: 6kV,CM: 6kV,Criterion B
Ring Wave	IEC/EN 61000-4-12	DM: 6kV,CM: 6kV,Criterion B

SS-100NH-V300BHB LED Driver

IEC (Intelligent Emergency Control) Description:

Connection Diagram

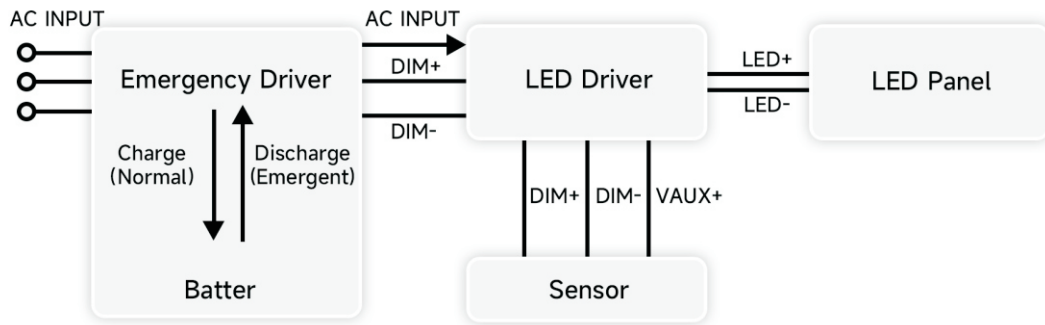

Emergency control logical diagram

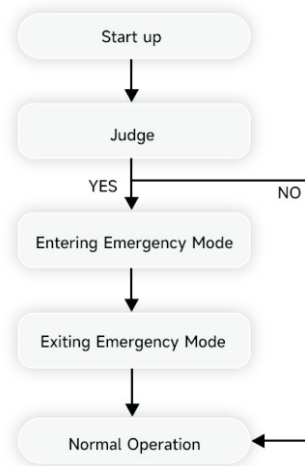

Technical Specifications for Emergency Lighting Communication Protocol

(1) Definition of Communication Levels: Active High Level: 4V - 10V (ON); Active Low Level: 0V - 0.3V (OFF).

(2) Positive Duty Cycle of Communication Signal: 25%.

(3) Entering Emergency Mode: The emergency driver supply will send a signal with 4Hz and a duty cycle of 25% after entering the emergency state. The LED driver supply must continuously detect this signal four times (signal duration of 30 seconds) before entering the emergency mode.

(4) Exiting Emergency Mode:

Scenario 1: Upon restoration of AC driver, the emergency driver supply sends a signal with 1Hz and a duty cycle of 25%. The LED driver supply must continuously detect this signal four times to exit the emergency mode.

Scenario 2: If it's timeout in the emergency state, the LED driver supply automatically exits the emergency mode after a default period of 2 hours (can be set).

Notes:

In the absence of a detected signal from the sensor (dimming line is a short circuit), the LED driver supply automatically exits the emergency mode after 2 hours. To ensure timely exit from the emergency mode, upon sensor signal detection (releasing the short circuit on the dimming line), the emergency driver supply continues to send the 1Hz exit signal for 2 hours after detecting the restoration of AC driver.

The LED driver supply is equipped with an emergency function switch that can be enabled through our proprietary PC software (default setting is "off"). For obtaining relevant emergency certifications, compatibility with the emergency driver supply system during certification is required.

When the emergency function is used, and the system is operating under no-load conditions or with the "Dim-off" function enabled, the system should delay switching to battery for 15 seconds after AC power loss.

SS-100NH-V300BHB LED Driver

Safety Test Items:

Safety Test Items	Technical Indicators		Remark
Insulation Requirements	UL Insulation Requirements	TUV Insulation Requirements	
Input-Case	2U+1000Vac	/	Basic insulation
Input-Dim	2U+1000Vac	/	Reinforced insulation
Dim-Case	500Vac	/	Basic insulation
Insulation Resistance	$\geq 10M\Omega$		Input-Dim, Test voltage: 500Vdc
Ground Resistance	$\leq 0.1\Omega$		25A/1min
Leakage Current	$\leq 0.75mA$		277Vac

NOTE:

1. SOSEN warrants the LED Driver itself complies with EMC standard. However, LED Driver's EMC should be re-checked when integrated into lighting systems due to unexpected interference of components.
2. Please short (ACL and ACN), (V+ and V-), (Dim+ and Dim - and Vaux+ and Vaux-) when Hi-pot test.

Performance Curves:

Input Inrush Current

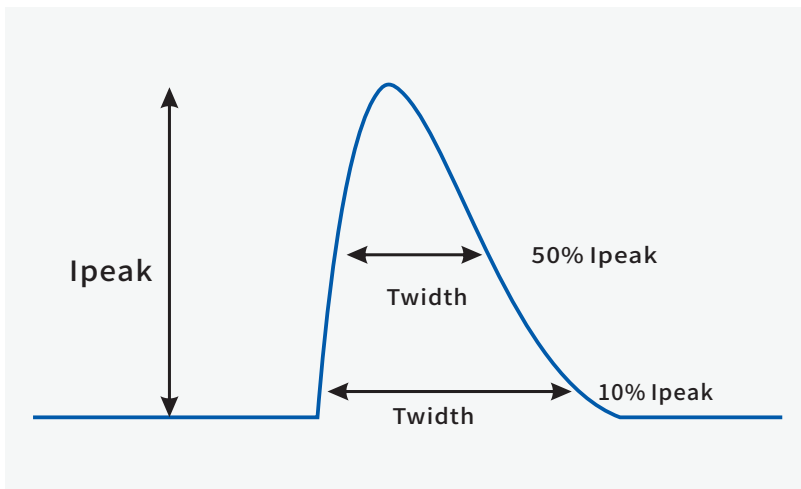

Vin	Ipeak	T(@10% of Ipeak)	T(@50% of Ipeak)
120Vac	40A	970uS	350uS
220Vac	80A	970uS	350uS
277Vac	120A	970uS	350uS

7/15

SS-100NH-V300BHB LED Driver

Performance Curves:

Output Voltage Vs. Output Current(Dim/AOC Window)

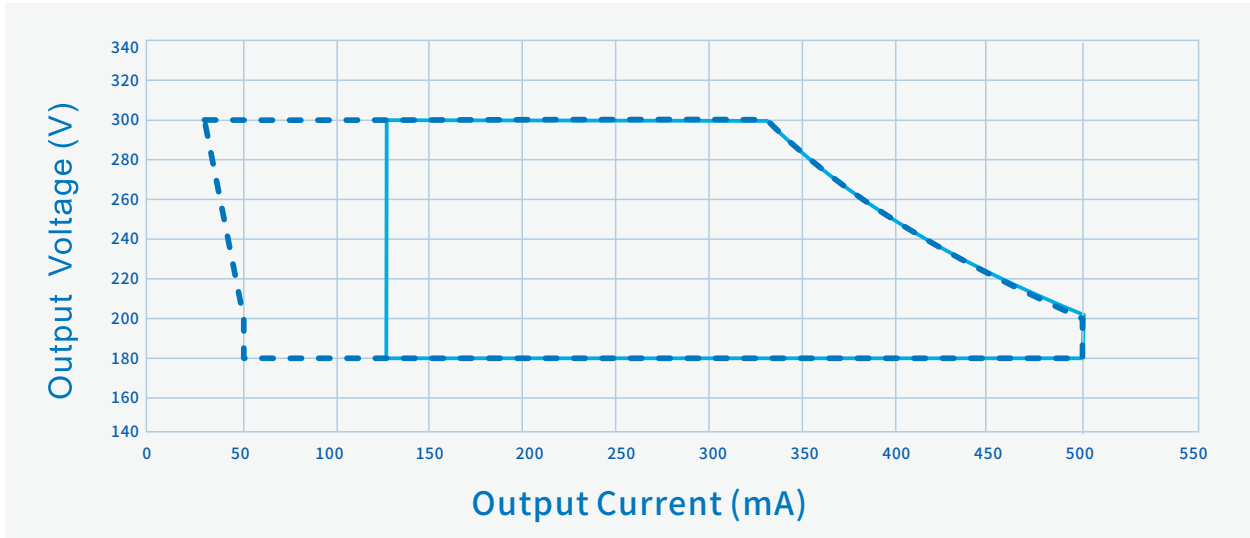

----- Dimming Window ————— AOC Window

Efficiency Vs. Output Voltage (Vin=120Vac)

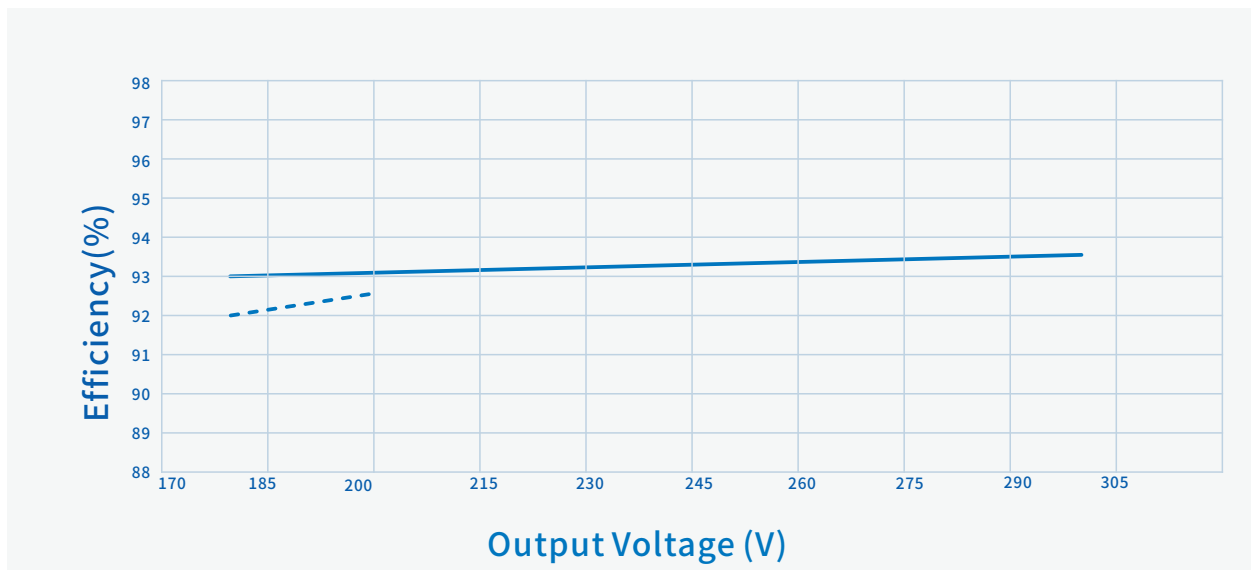

----- Io=500mA ————— Io=330mA

SS-100NH-V300BHB LED Driver

Performance Curves:

Efficiency Vs. Output Voltage ($V_{in}=220V_{ac}$)

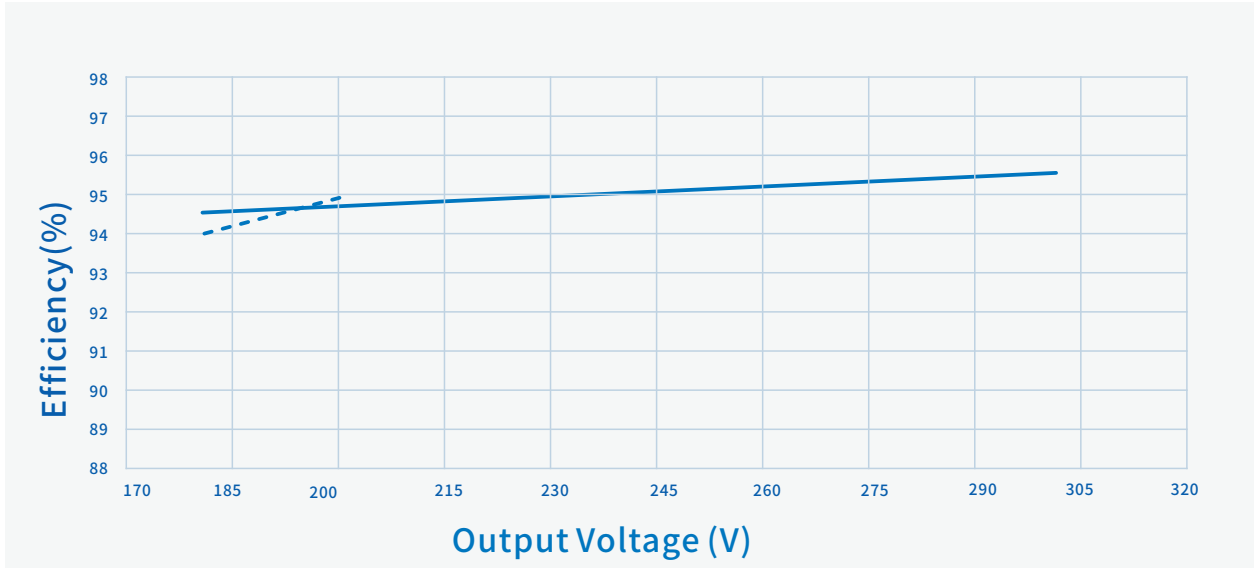

----- $I_o=500mA$

————— $I_o=330mA$

Efficiency Vs. Output Voltage ($V_{in}=277V_{ac}$)

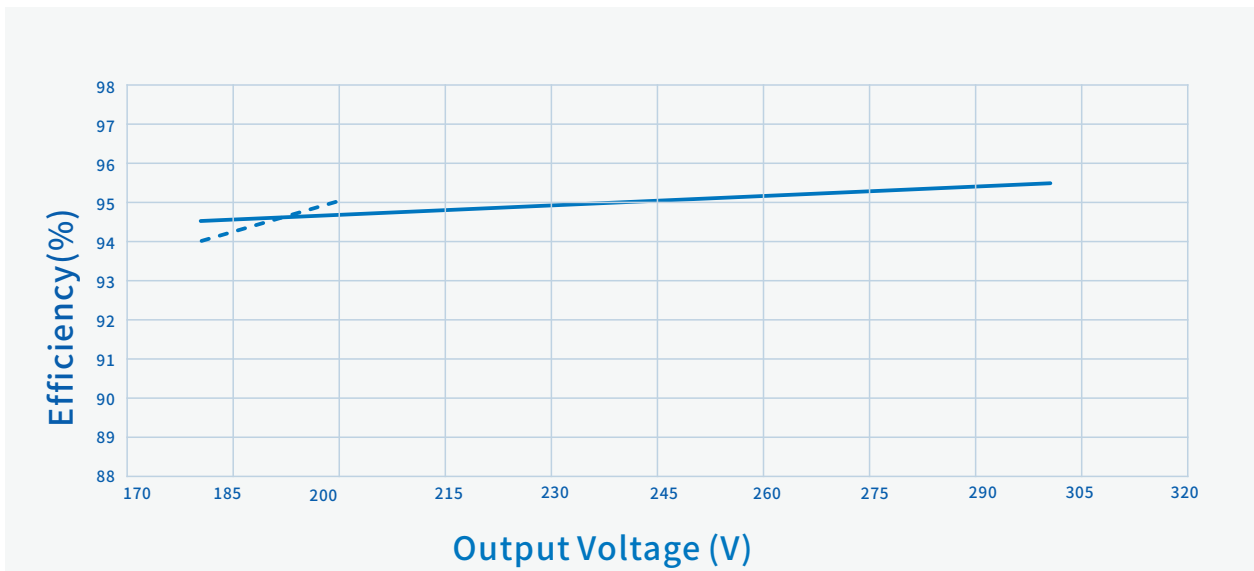

----- $I_o=500mA$

————— $I_o=330mA$

SS-100NH-V300BHB LED Driver

Performance Curves:

Power Factor Vs. Output Power

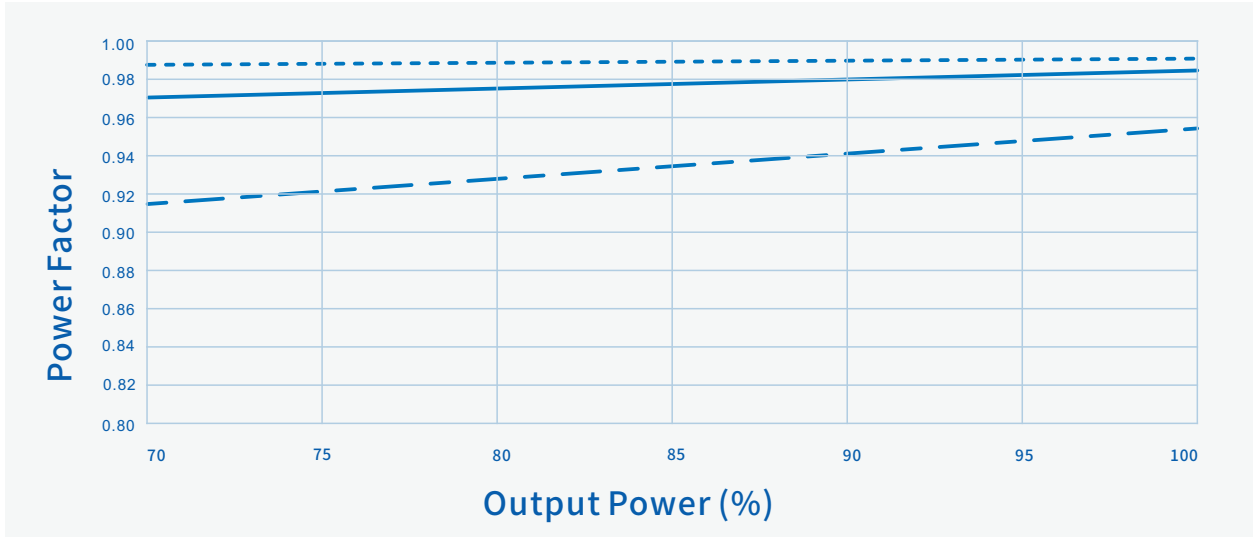

----- Vin=120Vac ——— Vin=220Vac - - - Vin=277Vac

THD Vs. Output Power

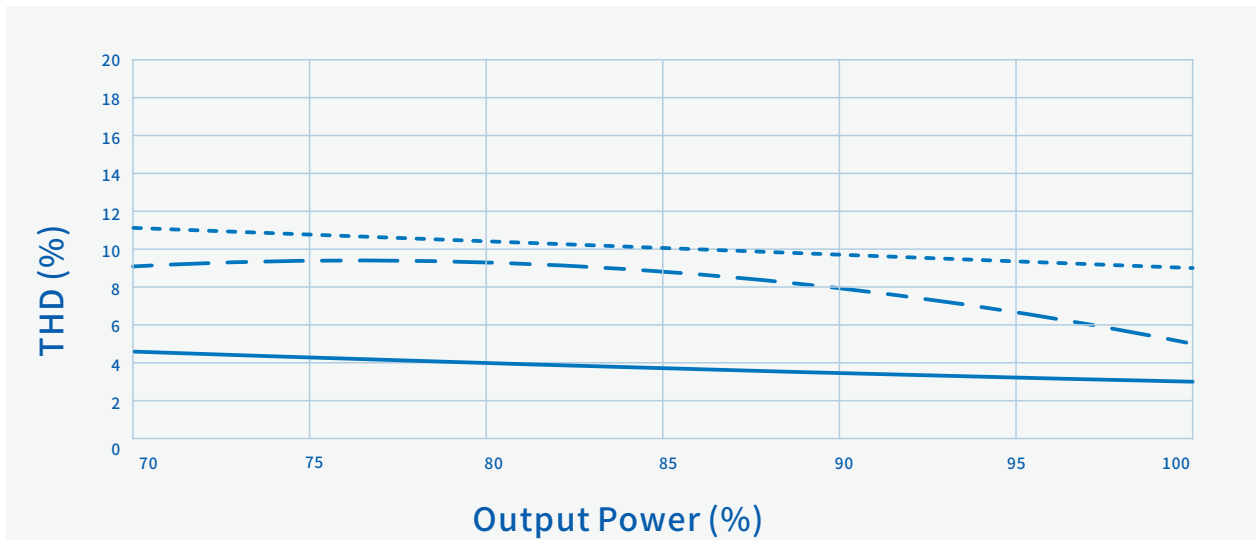

----- Vin=120Vac ——— Vin=220Vac - - - Vin=277Vac

SS-100NH-V300BHB LED Driver

Performance Curves:

Output Power Vs. Input Voltage

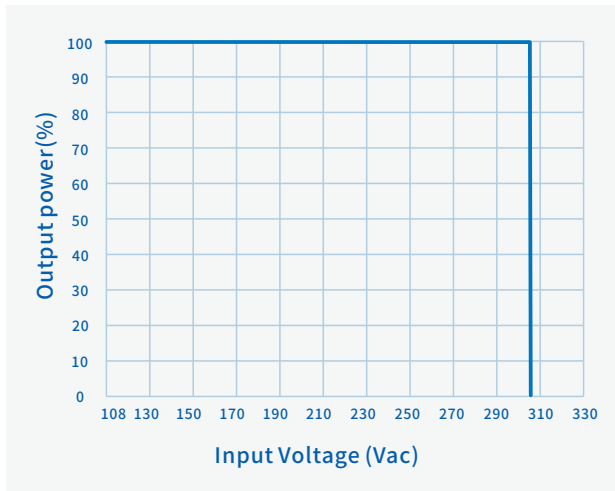

Output Power Vs. Case Temperature

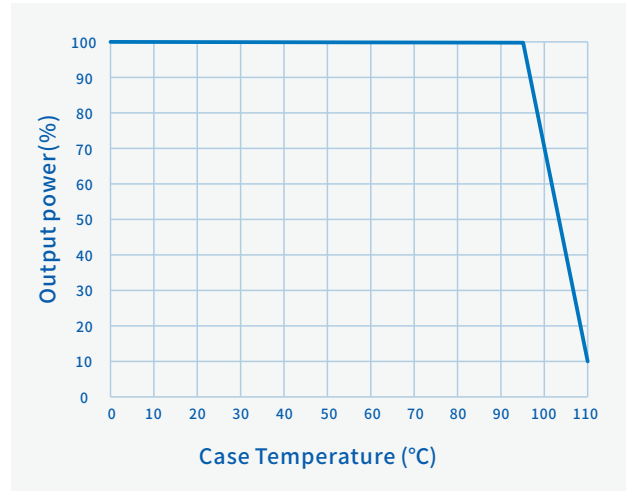

Output Power Vs. Dimming

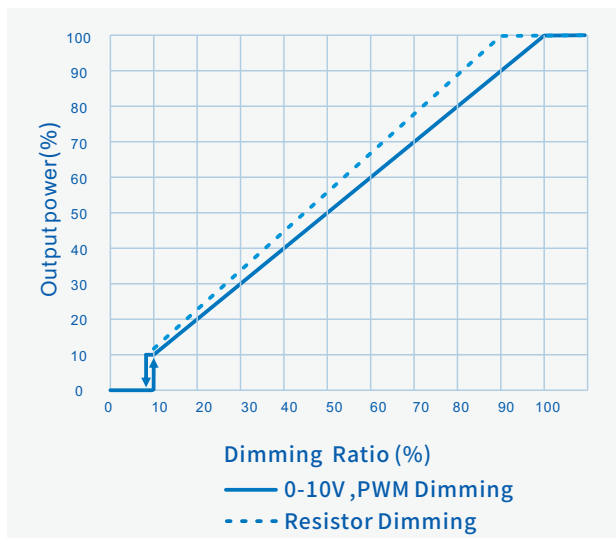

Lifetime Vs. Case Temperature

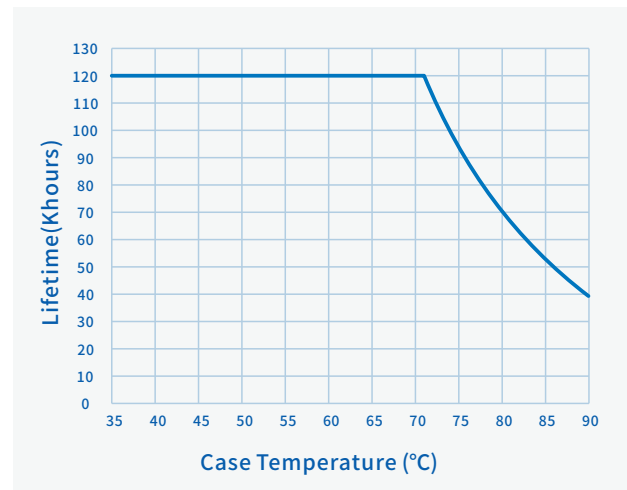

SS-100NH-V300BHB LED Driver

Programming connection diagram:

Legacy Timer: Driver's O/P follows the pre-programmed timing curve after turn-on.

Auto-Adjust by Percentage: Driver's O/P will be adjusted by automatically changed dimming curve by the period percentage based on the latest 5 dimming curve.

Auto-Adjust by Mid-point: Driver's O/P will be adjusted by automatically changed dimming curve by mid-point based on the latest 5 dimming curve.

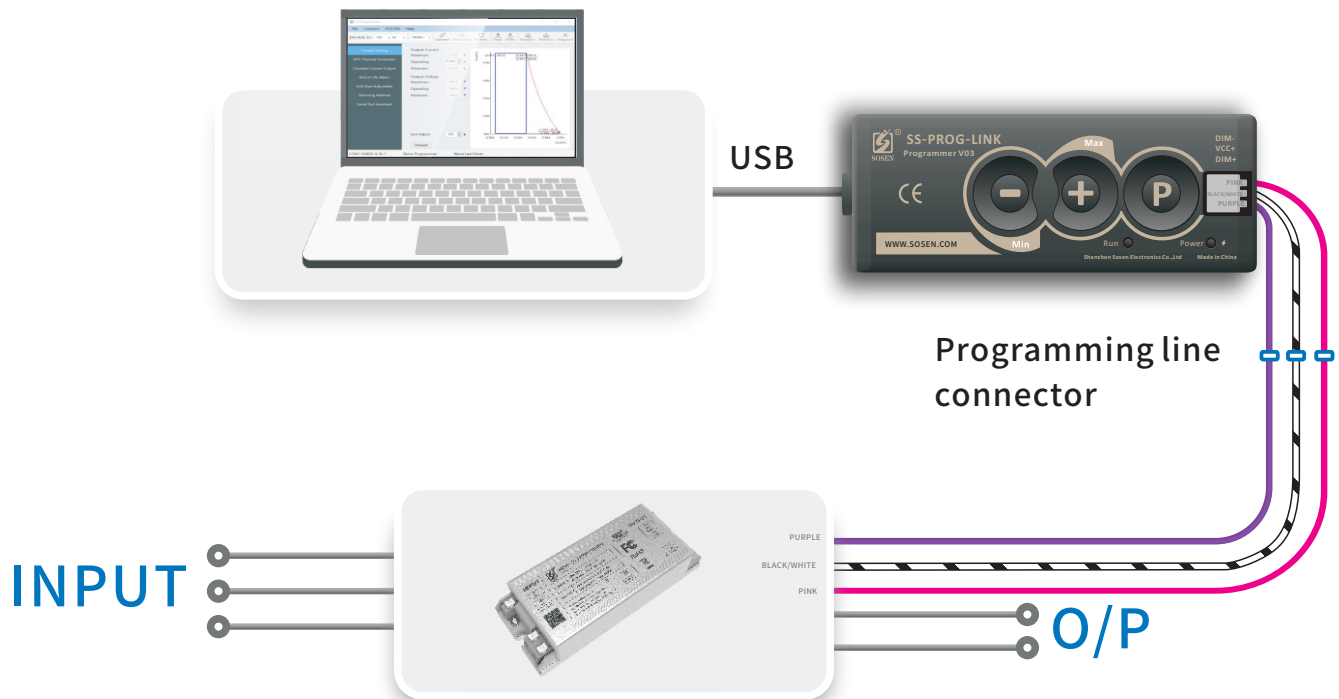

Note:

For details, please refer to the Sosen SS-PROG-LINK Programmer Manual.

SS-100NH-V300BHB LED Driver

Mechanical Characteristics

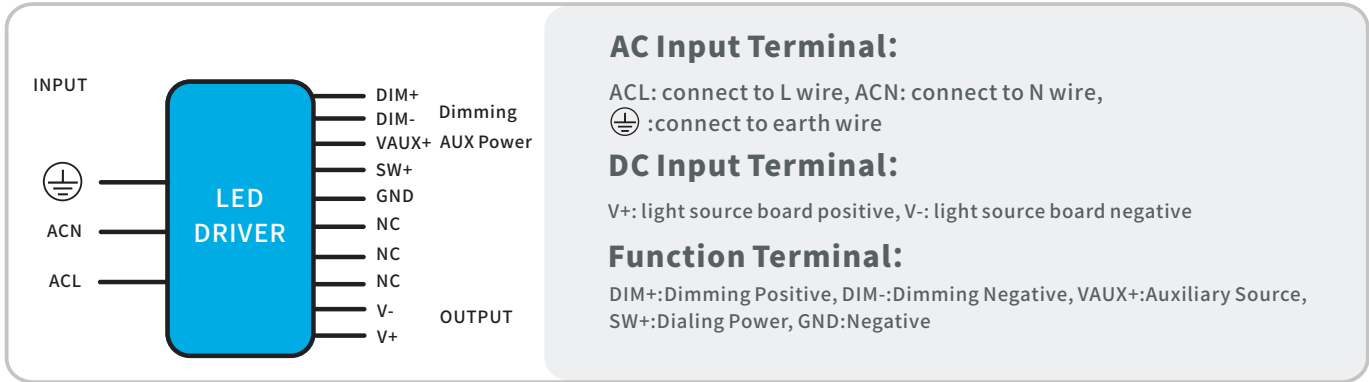

AC Input Terminal:

ACL: connect to L wire, ACN: connect to N wire,
⊕ :connect to earth wire

DC Input Terminal:

V+: light source board positive, V-: light source board negative

Function Terminal:

DIM+:Dimming Positive, DIM-:Dimming Negative, VAUX+:Auxiliary Source,
SW+:Dialing Power, GND:Negative

Name Description	Standard Code	mm(In.)
Case Length	L3	111(4.370)
Case Width	W1	55(2.165)
Case Height	H	32(1.259)
Overall Length	L1	138(5.433)
Mounting Hole Length	L2	130(5.118)
Mounting Hole Width	W2	27.5(1.083)
TC Point Position	X	65(2.559)
TC Point Position	Y	17(0.669)

Note:

1,Please follow the "LED Driver User Manual" obtained from SOSEN's official website for assembly.

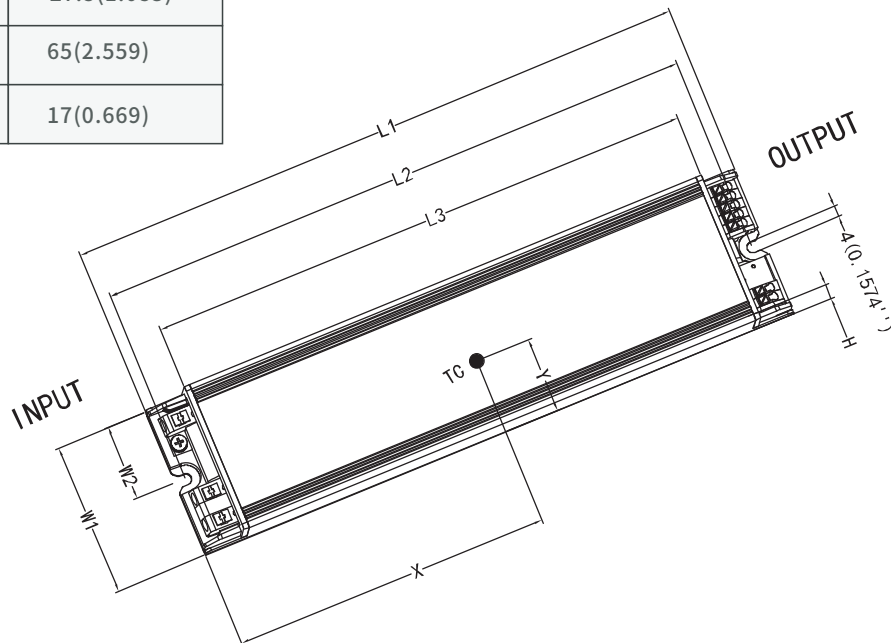

SS-100NH-V300BHB LED Driver



Assembly Tips

1. Safety space between aluminum base and LED coppers >5mm.
2. Safety space/coppers between LED+ and LED- >1.8mm.
3. Minimize the copper area on the aluminum PCB to reduce parasitic capacitance and leakage current.
4. It is recommended to design LED beads in parallel first and then in series.
5. The insulation level of LED light panels should meet the reliability design requirements.
6. For other precautions, please refer to the "LED Driver User Manual" .
7. SOSEN reserves the right of final interpretation of the above parameters.

Package

- Outside carton dimension: L×W×H=325mm×315mm×165mm;
- 40PCS/Carton;
- Net weight/Piece: 0.42kg;Gross weight/Carton: 17.8kg;
- Please refer to the product name, model number, manufacturer identification, QC PASS, manufacturing date on the package.

Transportation

Packaging is designed suitable for transportation by trucks, vessels and flights. The products should be avoided direct sunlight and rain, loaded/unloaded with caution.

Storage

The product storage meets the standard of the GB 3873—83.
Products should be rechecked if stored for over 1 year before assembly.

RoHS

Products comply with RoHS Directive (2011/65/EU) and amendment 2015/863/EU.

Revision History

Version	Description of Update	Updated Date	Remark
V00	Original Release	2024/09/08	
V01	Updated intelligent emergency controls	2024/11/23	

