



# SOSEN LED Driver, Your Smart Choice

## Specifications

### SS-320NH-E(62) Series LED Driver

Model: SS-320NH-E260\*

Description: 320W LED Driver

Rev.: V01

Release Date: 2023-08-07

# SS-320NH-E(62) Series LED Driver

**SOSEN**  
LED DRIVER



**LED DRIVER**

**NH-E(62) Series**



## Features:

- Efficiency up to 96%
- Dimming: 0-10V,PWM,Resistor
- Isolated Dim-to-off
- AUX Power : 12V/0.2A
- Standby power<0.5W
- Protections: SCP/OTP/OVP
- Surge protection: CM: 6kV, DM: 6kV
- Warranty: 5 years



**Class P**

## Description:

SS-320NH-E(62) Series are 320W non-isolated constant current LED Driver with 90-305VAC. It has DIM to Off, high efficiency, isolated auxiliary power supply, compact housing ,fullypotted , high reliability, high cost performance and other advantages.

Applications:

Wall washers, Linear high bay lighting, Flood lighting, Wall lighting

## Model List:

Model	AC Input Range	Max. Pout	Vout Range	Full Power Vo Range	Iout	THD(Typ.)	PF(Typ.)	Eff.(Typ.)	Max.Tc
SS-320NH-E260*	90-305Vac	320W	180-260V	214V-260V	1.1-1.5A	8%	0.97	96%	90°C

Note:

1.Default Tested: at 220Vac, full load, Ta 25°C.

2.The performance of the LED Driver can be guaranteed within the full power Vo range.The voltage lower than full power Vo range, it is need to test the performance with the LED module.

# SS-320NH-E(62) Series LED Driver

## “\*” Means Additional Function

“*”	AUX 12V (suffix:H)	Dimming off 0-10V/PWM/Resistor	Adjust power (Single DIP)	Optical control	Remark
BH	✓	✓			
BHB	✓	✓	✓		
BHP	✓	✓		✓	
BHBP	✓	✓	✓	✓	

## Input Characteristics:

Parameter	Min.	Typ.	Max.	Remark
Rated AC Input Range	100Vac		277Vac	Ref. derating curve
AC Input Range	90Vac		305Vac	Ref. derating curve
Input Frequency Range	47Hz	50/60Hz	63Hz	
Max Input Current			3.5A	120Vac, Full load
Max Input Power			355W	120Vac, Full load
Max Inrush Current(120Vac)			80A	Cold start
Max Inrush Current(220Vac)			120A	Cold start
Max Inrush Current(277Vac)			150A	Cold start
Standby Power			0.5W	220Vac/50Hz, Dim to off
Power Factor	0.95	0.97		220Vac/50Hz, Full load
	0.90			100-277Vac/50Hz, 70%-100% load
THD		8%	10%	220Vac/50Hz, Full load
			20%	100-277Vac/50Hz, 70%-100% load

# SS-320NH-E(62) Series LED Driver

## Output Characteristics:

Parameter	Min.	Typ.	Max.	Remark
O/P Voltage Range	180V		260V	Power derated @180-214V
Rated O/P Voltage	214V		260V	$P_o = V_o \cdot I_o = 320W$ , Full load
Rated O/P Current	1.23A		1.5A	1.5A for 214V, 1.23A for 260V
Adj. O/P Current (AOC) Range	1.1A		1.5A	
No Load Voltage			310V	
Efficiency @120Vac	91.0%	93.0%		Output 260V/1.23A
Efficiency @220Vac	94.0%	96.0%		Output 260V/1.23A
Efficiency @277Vac	94.0%	96.0%		Output 260V/1.23A
O/P Current Tolerance	-5%		+5%	
O/P Current Ripple(PK-AV)		5%	10%	Full load
Start-up Current Overshoot			10%	Full load
Start-up Time			1.0S	120Vac, Full load
			0.5S	220Vac, Full load
Line Regulation	-2%		+2%	Full load
Load Regulation	-6%		+6%	
Temperature Coefficient	-0.05%/°C		+0.05%/°C	Tc: 0°C~90°C
OTP	90°C	100°C	110°C	>Tc Typ., Current derating <Tc Min., Current recovery
Short Circuit Protection				Driver will not be damaged

# SS-320NH-E(62) Series LED Driver

## Other Characteristics:

Parameter		Min.	Typ.	Max.	Remark
Aux Power	O/P Voltage	10.8V	12V	13.8V	
	O/P Current			200mA	
0-10V Dimming	Dim Vmax	0V		12V	DIM+ source max current 100uA.
	Dim Range	10%Iomax		100%Ioset	Dimming prohibits reverse connection
	Rec.Dim Range	0V		10V	
PWM Dimming	PWM High	9.8V		10.2V	DIM+ source max current 100uA.
	PWM Low	0V		0.3V	Dimming prohibits reverse connection
	Frequency	1KHz		2KHz	
	PWM Duty	0%		100%	
Resistor Dimming	Resistance	0Kohm		100Kohm	DIM+ source max current 100uA.
	Dim Range	10%Iomax		100%Ioset	
Dim to Off	Dim off	0.7V	0.8V	0.95V	
	Dim on	0.95V	1.1V	1.2V	
Lifetime(Tc≤85°C)		≥50,000 hours			
MTBF		200,100 hours			220Vac, Full load, Ta=25°C (MIL-HDBK-217F)
Tc		90°C			
Warranty		5 years			Tc: 85°C
Net Weight		580g			
Dimension		230mm*45mm*31mm			L x W x H

NOTE: All the parameters above are tested Ta 25°C and LED load, unless specified.

# SS-320NH-E(62) Series LED Driver

## Environmental Requirements

Parameter	Min.	Typ.	Max.	Remark
Operating Temperature(Tcase)	-40°C	25°C	+90°C	
Storage Temperature	-40°C	25°C	+90°C	
Operation Humidity	10%RH		90%RH	
Storage Humidity	5%RH		95%RH	
Altitude	-65m		4000m	

## Safety and EMI/EMS Standards

Certification	Standard	Status	Remark
UL/cUL	UL8750	✓	
TUV	EN 61347-2-13:2014/A1:2017 EN61347-1:2015 EN62493:2015		
RCM	AS/NZS61347.2.13		
BIS	IS15885:2012 Part 2 Sec 13		
CCC	GB 19510.14-2009		
CE	EN 61347-2-13:2014 EN61347-1:2008+A1:2011+A2:2013		

EMI/EMS	Criterion	Remark
Conduction Emission	FCC Part 15 Subpart B; ANSI C63.4:2014	120Vac: Class B, 277Vac: Class A
Radiation Emission	FCC Part 15 Subpart B; ANSI C63.4:2014	120Vac: Class B, 277Vac: Class A
Harmonic Current Emissions	IEC/EN 61000-3-2:2019+A1:2021	Class C
Surge	IEC/EN61000-4-5	DM: 6kV,CM: 6kV,Criterion B
Ring Wave	IEC/EN 61000-4-12	DM: 6kV,CM: 6kV,Criterion B

# SS-320NH-E(62) Series LED Driver

## Safety Test Items:

Safety Test Items	Technical Indicators	Remark
Insulation Requirements	UL Insulation Requirements	
Input-Case	1600Vac	Basic insulation
Input-Dim	1600Vac	Reinforced insulation
Dim-Case	500Vac	Basic insulation
Insulation Resistance	$\geq 10M\Omega$	Input-Dim,Test voltage:500Vdc
Ground Resistance	$\leq 0.1\Omega$	25A/1min
Leakage Current	$\leq 0.75mA$	277Vac

### NOTE:

1. SOSEN warrants the LED Driver itself complies with EMC standard. However, LED Driver's EMC should be re-checked when integrated into lighting systems due to unexpected interference of components.
2. Please short (ACL and ACN), (V+ and V-), (Dim+ and Dim - and Vaux+ and Vaux-)when Hi-pot test.

## Performance Curves:

### Input Inrush Current

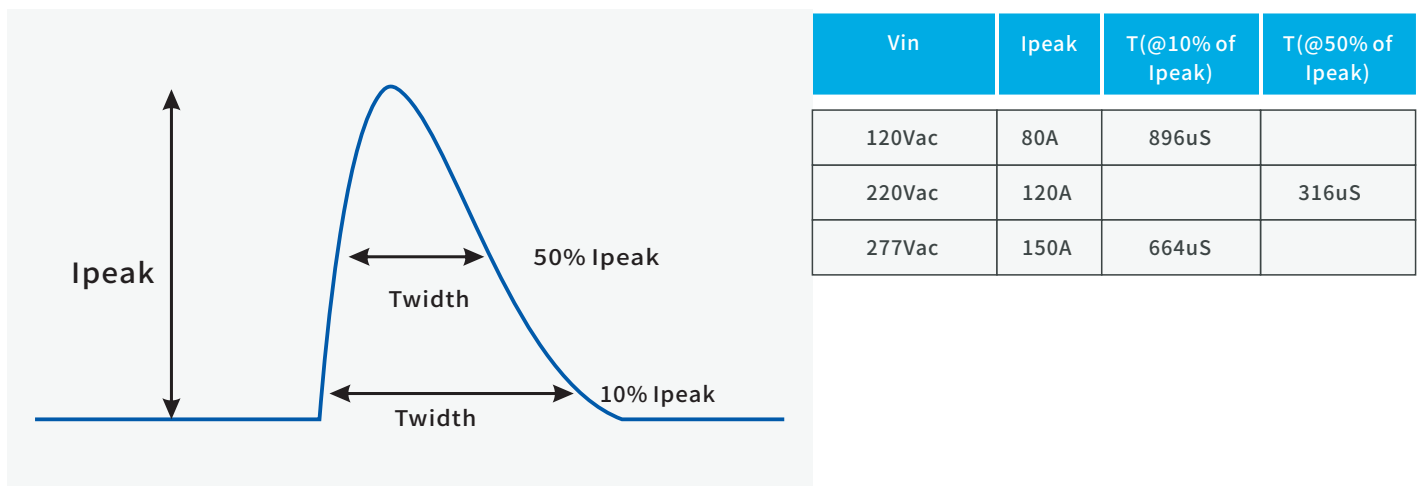

# SS-320NH-E(62) Series LED Driver

## Performance Curves:

### Output Voltage Vs. Output Current(Dim/AOC Window)

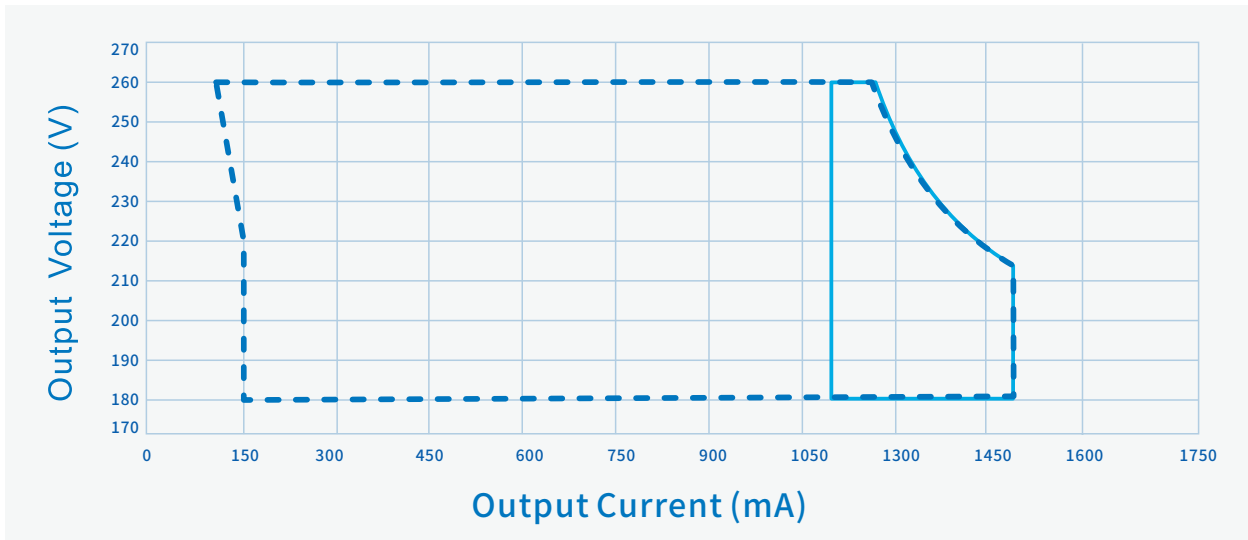

----- Dimming Window      ————— AOC Window

### Efficiency Vs. Output Voltage (Vin=120Vac)

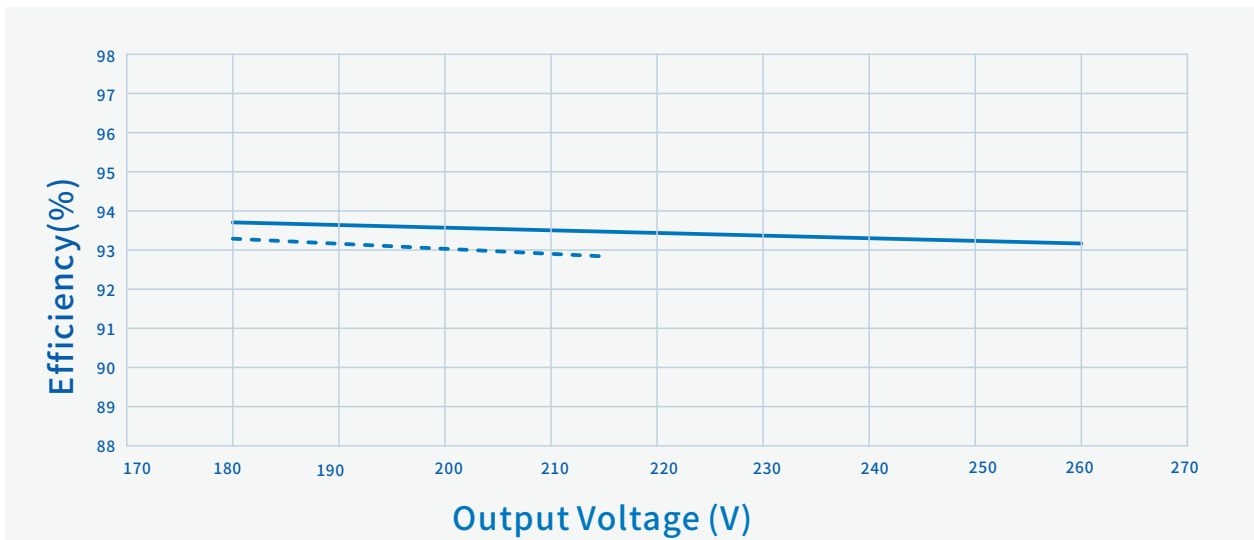

----- Io=1500mA      ————— Io=1230mA



# SS-320NH-E(62) Series LED Driver

## Performance Curves:

Efficiency Vs. Output Voltage ( $V_{in}=220V_{ac}$ )

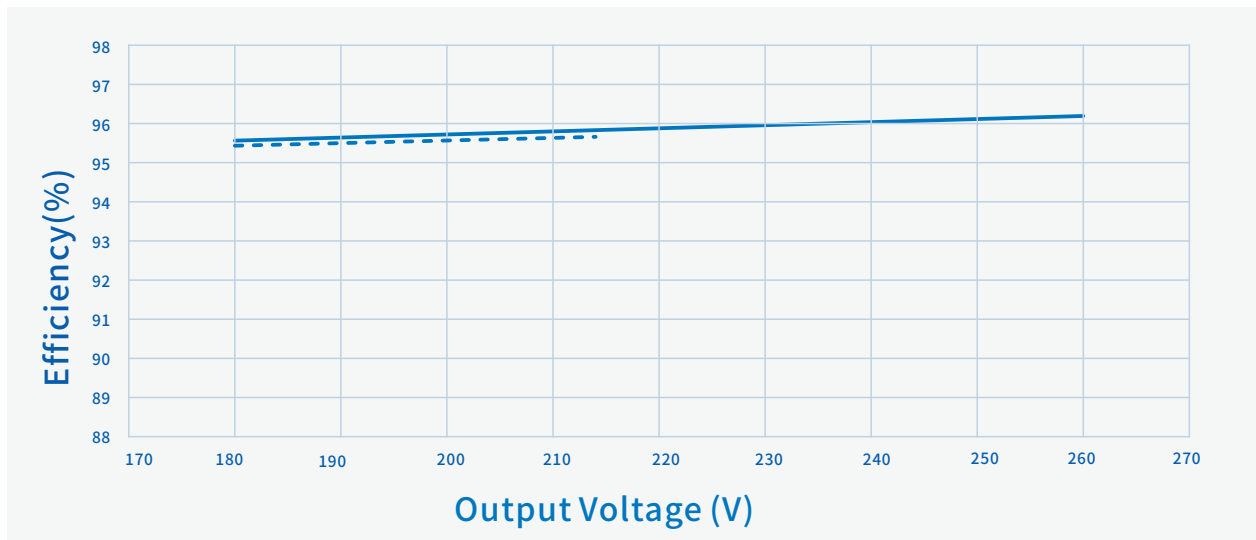

-----  $I_o=1500mA$

—————  $I_o=1230mA$

Efficiency Vs. Output Voltage ( $V_{in}=277V_{ac}$ )

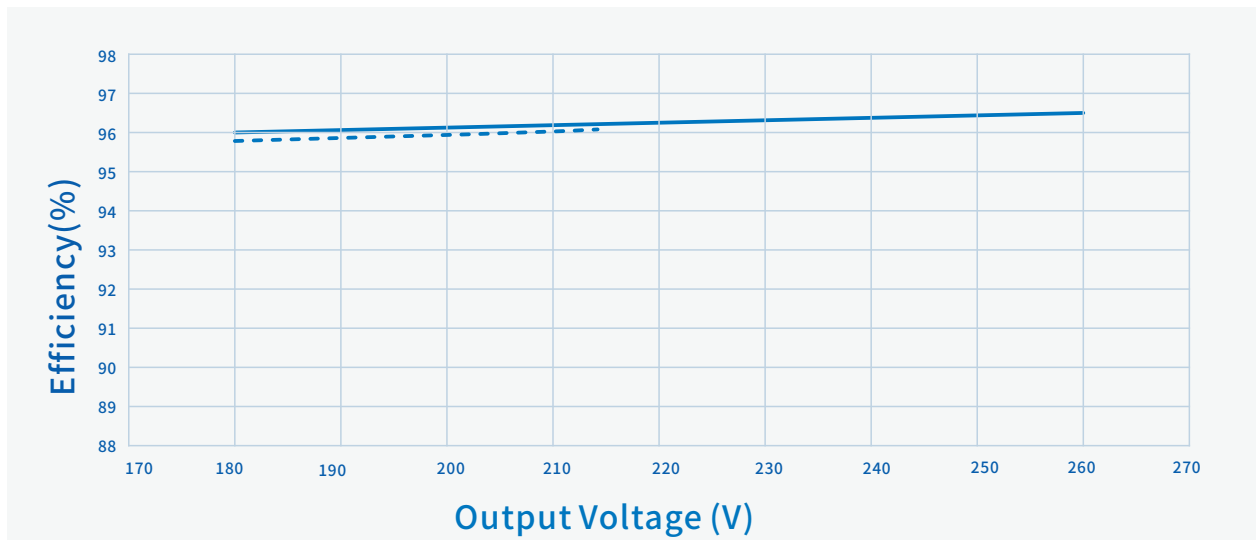

-----  $I_o=1500mA$

—————  $I_o=1230mA$

# SS-320NH-E(62) Series LED Driver

## Performance Curves:

### Power Factor Vs. Output Power

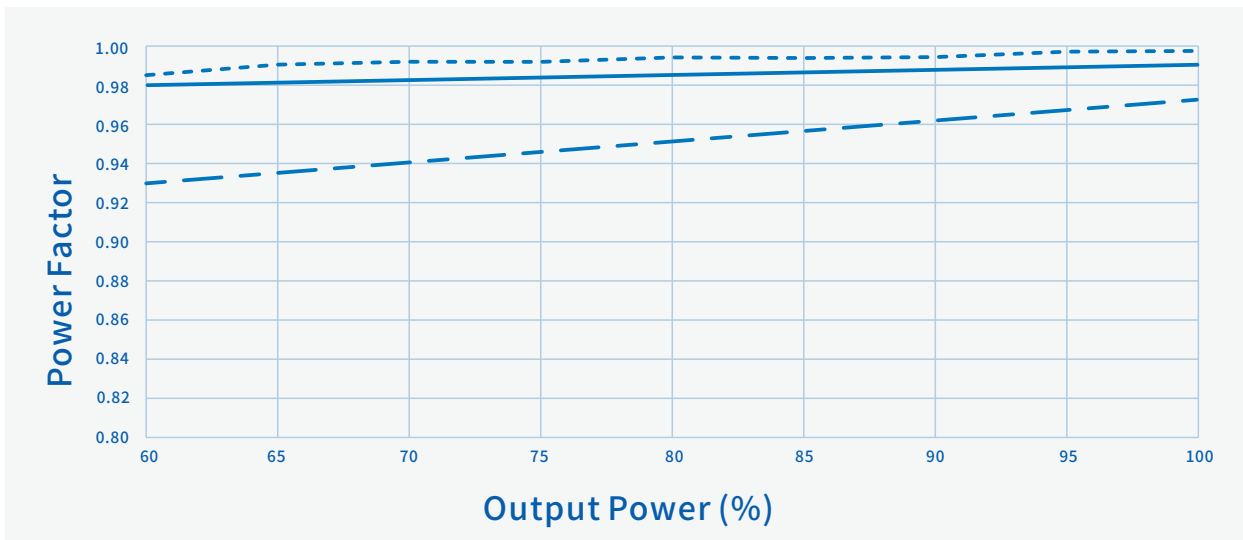

----- Vin=120Vac      ————— Vin=220Vac      - - - - Vin=277Vac

### THD Vs. Output Power

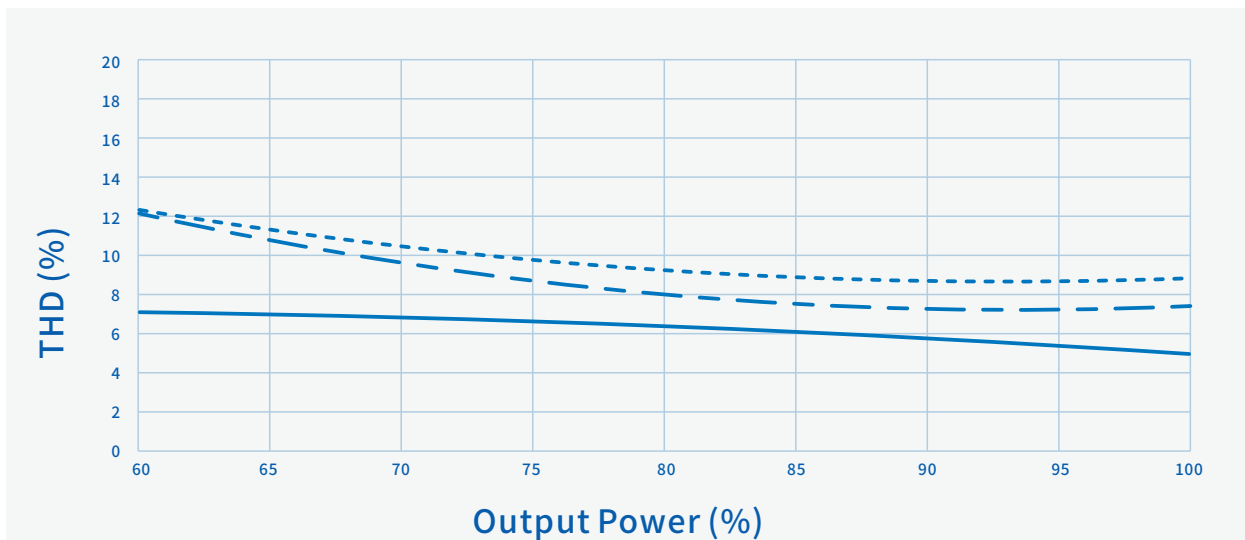

----- Vin=120Vac      ————— Vin=220Vac      - - - - Vin=277Vac

# SS-320NH-E(62) Series LED Driver

## Performance Curves:

### Output Power Vs. Input Voltage

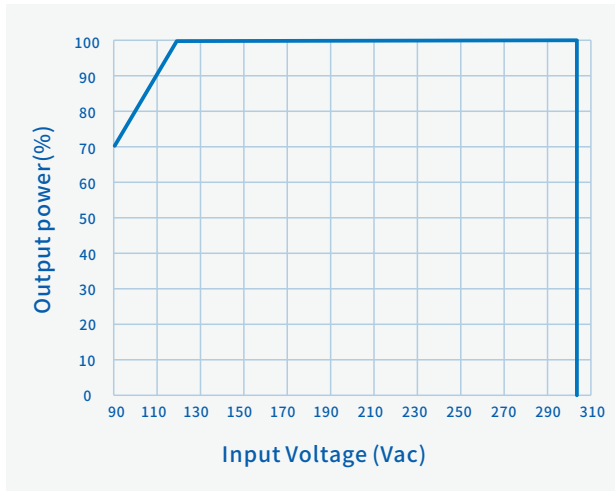

### Output Power Vs. Case Temperature

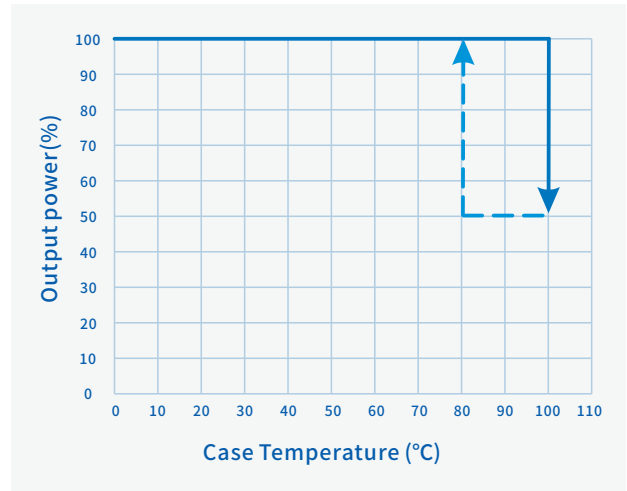

### Output Power Vs. Dimming

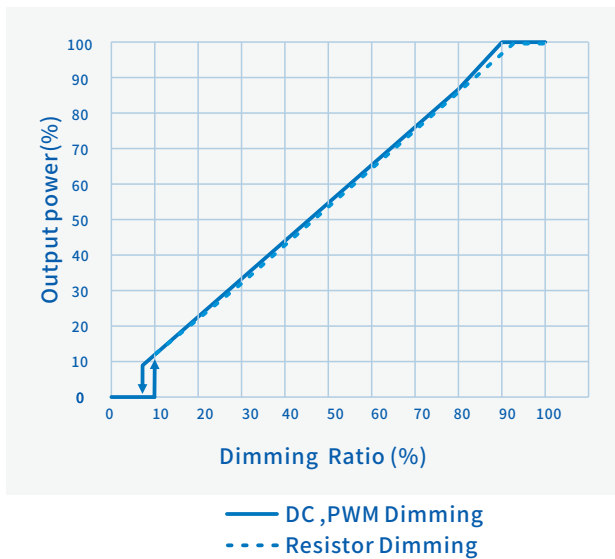

### Lifetime Vs. Case Temperature

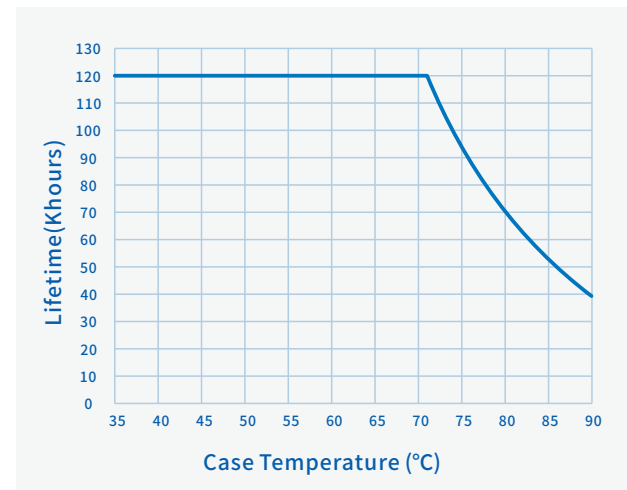

# SS-320NH-E(62) Series LED Driver

## Mechanical Characteristics

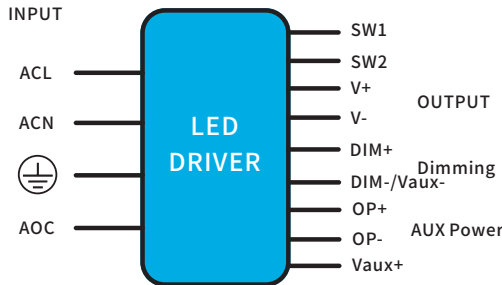

### AC Input Cable(Exposed Length 300±10mm):

UL/EU model: 18AWG 105°C 600V O.D: 2.77mm,Black:ACL,White:ACN,Green:⊕

### DC Output Cable(Exposed Length 300±10mm):

UL/EU model: 18AWG 105°C 300V O.D: 1.95mm,Red:V+, Black:V-

### Resistance power regulating line with terminal Cable:

UL/EU model: 24AWG 150°C 300V O.D: 1.6mm,Orange: SW1,SW2

### Optical control line with terminal:

UL/EU model: 24AWG 150°C 300V O.D: 1.6mm,Red: OP+,Black: OP-

### DIM/AUX Power Cable(Exposed Length 220±10mm):

UL/EU model: 22AWG 105°C 300V O.D: 1.52mm, Purple: DIM+, Pink: DIM-/Vaux-, Black/White: Vaux+

Name Description	Standard Code	mm(In.)
Case Length	L3	215(8.46)
Case Width	W2	45(1.77)
Case Height	H	31(1.22)
Overall Length	L1	230(9.06)
Mounting Hole Length	L2	223(8.78)
Mounting Hole Width	W1	32(1.26)
TC Point Position	X	47(1.85)
TC Point Position	Y	24(0.94)

#### Note:

- Please follow the "LED Driver User Manual" obtained from SOSEN's official website for assembly.
- AC Input Cable,DC O/P Cable,DIM Cable:  
Tinned length of wire:10±2mm

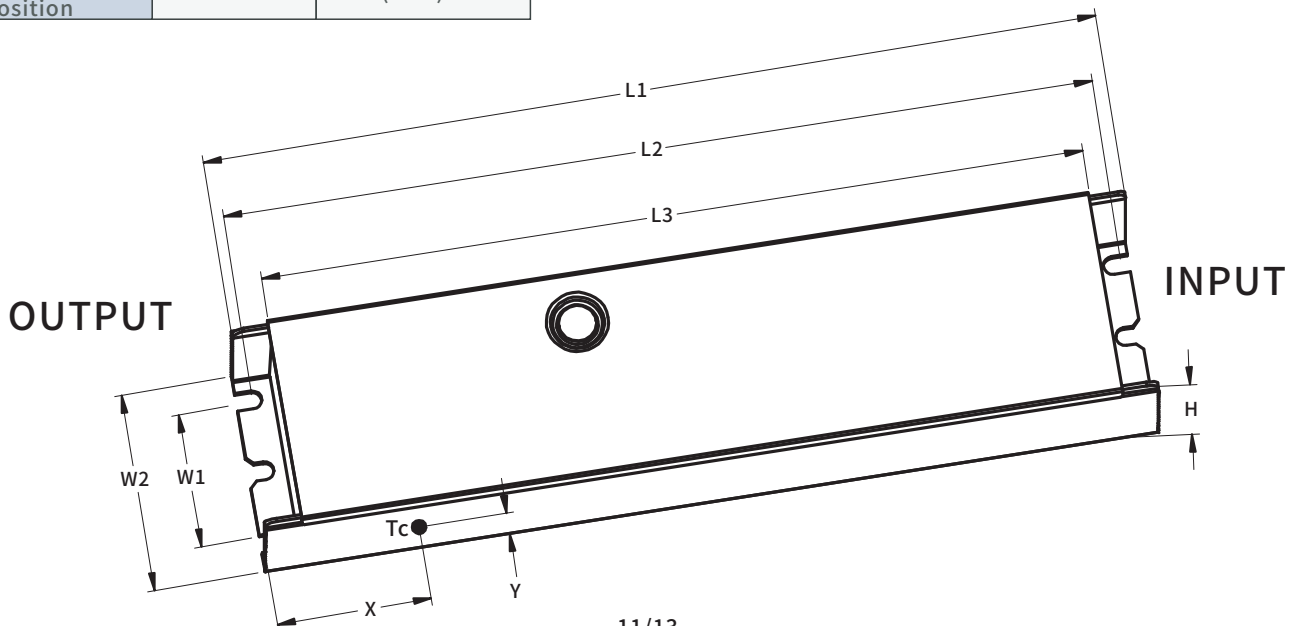

# SS-320NH-E(62) Series LED Driver



## Assembly Tips

1. Highly recommended to seal the adjustable hole with silicon glue(#704 preferred) after adjusting the Driver's output current. Avoid permanent damage to adjust the potentiometer with suitable strength.
2. Dimming or AUX Power tinned connectors should be capped if not used to avoid dimming or AUX Power parts damage from external signals.
3. In order to meet the requirements of the power derating and the maximum ambient temperature of 50°C, an auxiliary heat sink must be added. It is recommended that the heat sink has a heat dissipation area of 380cm<sup>2</sup> and volume of 115cm<sup>3</sup>. Thermal grease should be applied between led driver and the auxiliary heat sink to ensure the bottom of housing is in close contact with the heat sink.
4. Safety space between aluminum base and LED coppers >5mm.
5. Safety space/coppers between LED+ and LED- >1.8mm.
6. Minimize the copper area on the aluminum PCB to reduce parasitic capacitance and leakage current.
7. It is recommended to design LED beads in parallel first and then in series.
8. The insulation level of LED light panels should meet the reliability design requirements.
9. For other precautions, please refer to the "LED Driver User Manual" .
10. SOSEN reserves the right of final interpretation of the above parameters.

## Package

- Outside carton dimension: L×W×H=495mm×385mm×162mm;
- 24PCS/Carton;
- Net weight/Piece: 0.58kg;Gross weight/Carton: 15.6kg;
- Please refer to the product name, model number, manufacturer identification, QC PASS, manufacturing date on the package.

## Transportation

Packaging is designed suitable for transportation by trucks, vessels and flights. The products should be avoided direct sunlight and rain, loaded/unloaded with caution.

## Storage

The product storage meets the standard of the GB 3873—83.  
Products should be rechecked if stored for over 1 year before assembly.

## RoHS

Products comply with RoHS Directive (2011/65/EU) and amendment 2015/863/EU.

## Revision History

Version	Description of Update	Updated Date	Remark
V00	Original Release	2023/06/15	
V01	Update Additional Function	2023/08/07	

